

# ControlMySpa™

*Spa Owner User Guide*

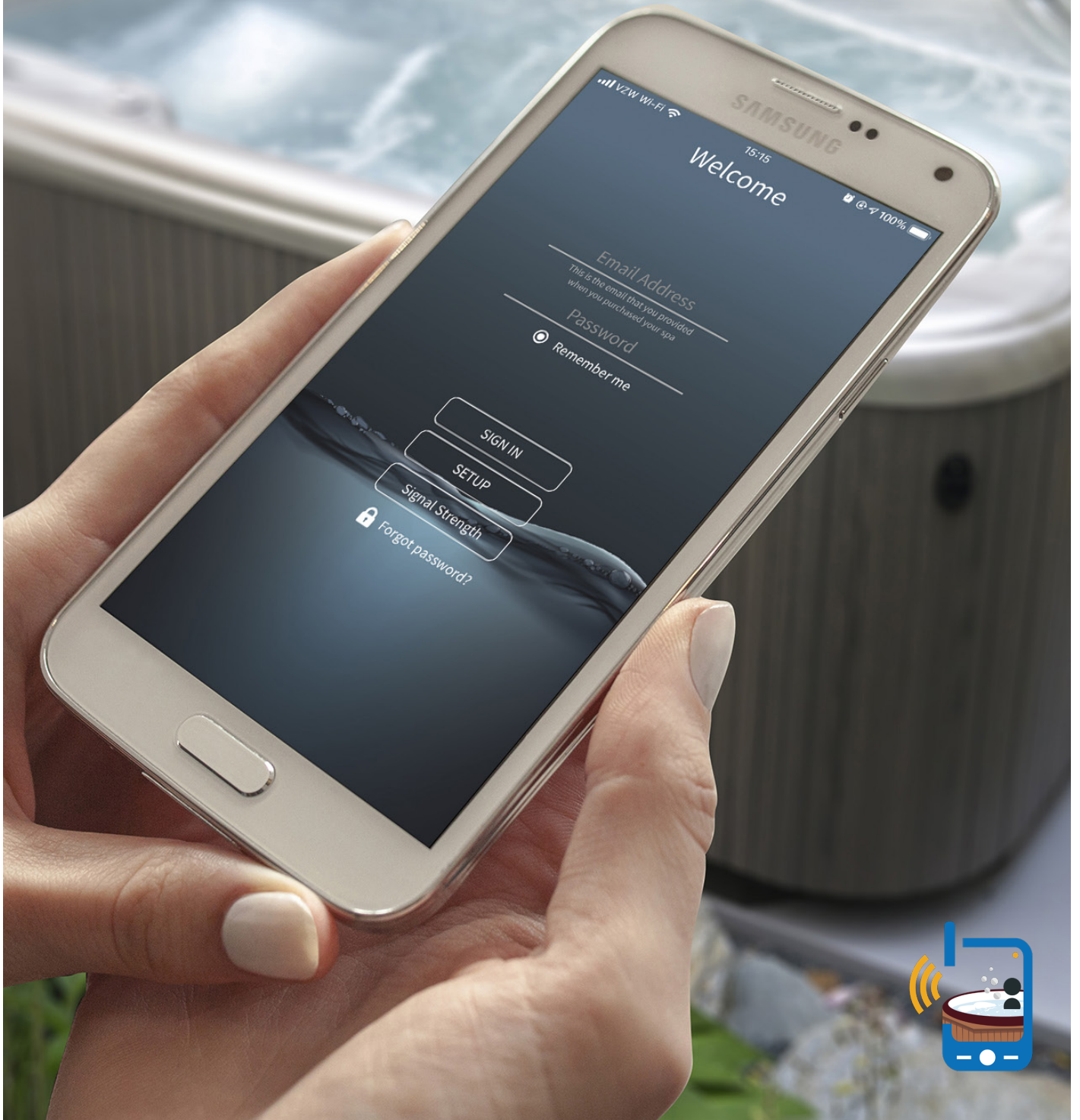



# TABLE OF CONTENTS

CONTROLMYSPA™ SYSTEM OVERVIEW   01	3
GATEWAY ULTRA HARDWARE CONNECTIONS   02	5
CMS™ CODE OVERVIEW   03	7
SETTING UP THE CONTROLMYSPA™ APP   04	9
CONTROLMYSPA™ WEBSITE – SPA OWNER OVERVIEW   05	17
INFORMATION MENU   06	20

ControlMySpa™ was built to provide the Spa Professionals with real-time access to the tub so you will think you are actually standing next to it. And, for your Customer, peace of mind, new app features, the ability to schedule events and equip smart heating so your spa is ready to go when you are.

# WELCOME TO CONTROLMYSPA™

## Overview

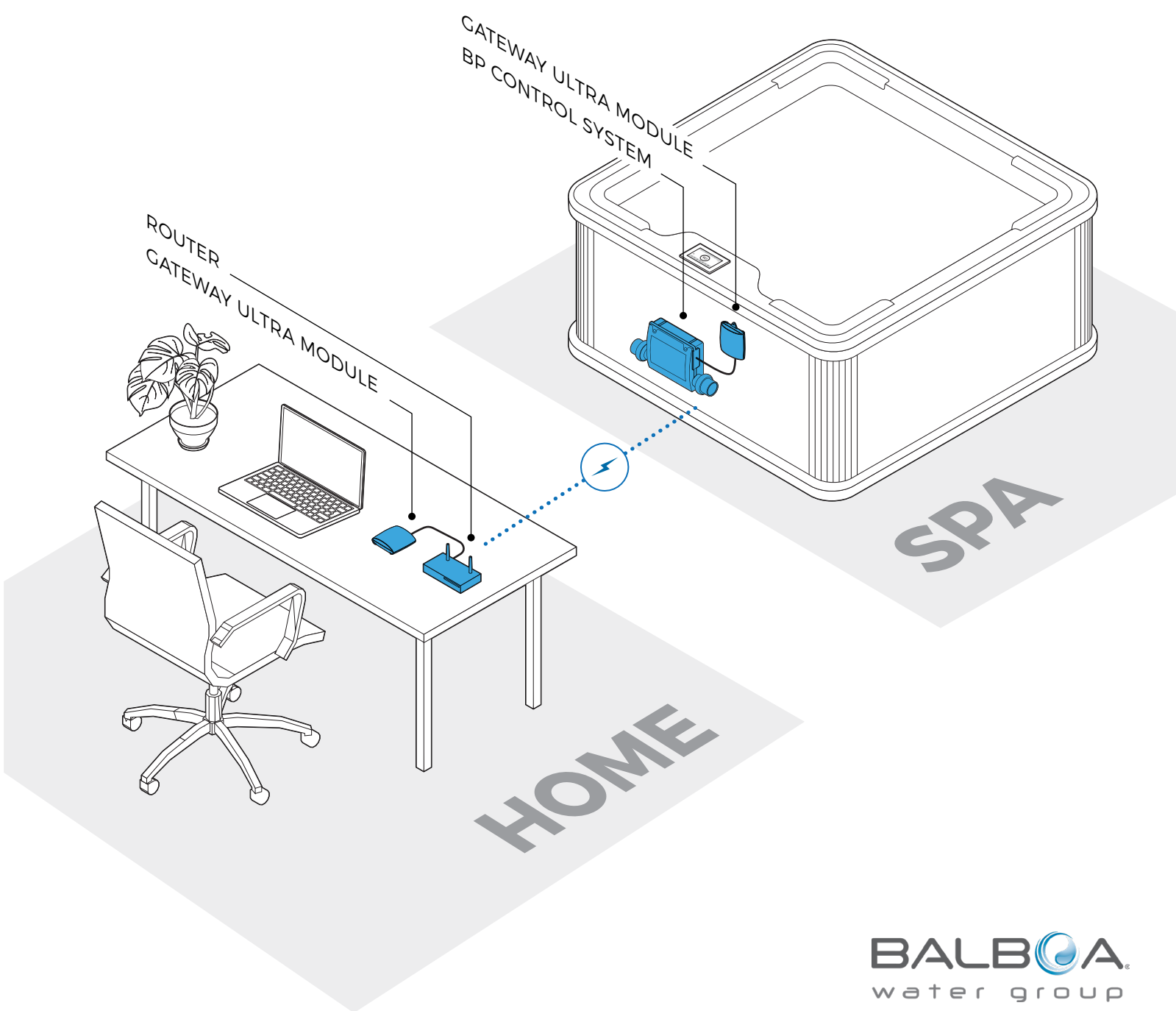

# ControlMySpa™

## CMS™ SYSTEM CONSISTS OF:

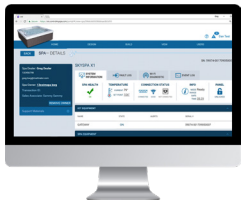

### WEBSITE

ControlMySpa™ website with  
Login and access to spas

## CMST™ GATEWAY ULTRA Modules



Home Module



Spa Module

[www.balboawater.com/GatewayUltra](http://www.balboawater.com/GatewayUltra)

## SMARTPHONE | TABLET



iOS (Apple) ControlMySpa™  
mobile app and/or Android  
ControlMySpa™ Mobile app

The ControlMySpa™ system consists of:

- ControlMySpa™ GATEWAY ULTRA installed on a spa/Hot Tub
- iOS (Apple) ControlMySpa™ mobile app or Android ControlMySpa™ mobile app
- ControlMySpa™ website with log-in and access to spas

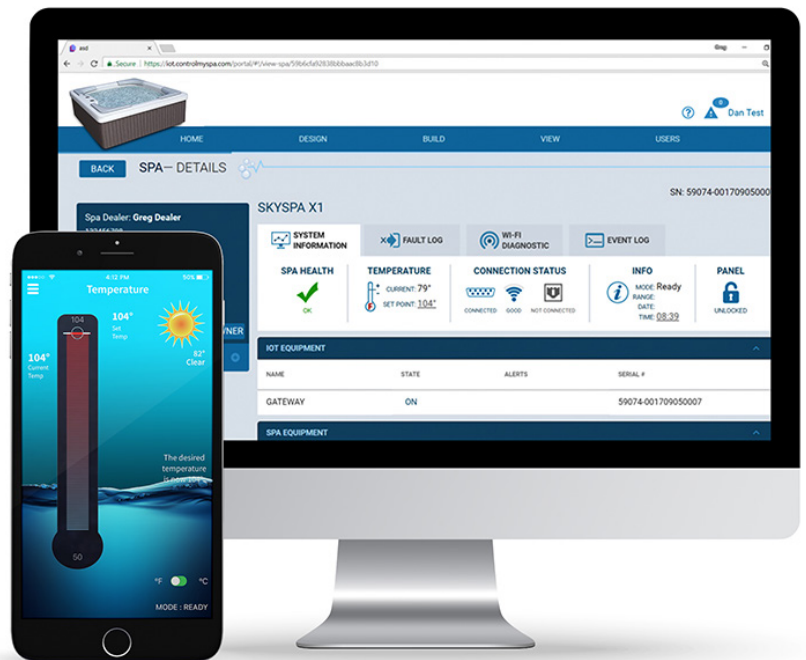

The ControlMySpa™ Logins:

- The iOS or Android ControlMySpa™ apps can only be accessed with an owner log-in
- The ControlMySpa™ website can be accessed with an owner log-in.

# ControlMySpa™

## GATEWAY ULTRA Hardware Connections

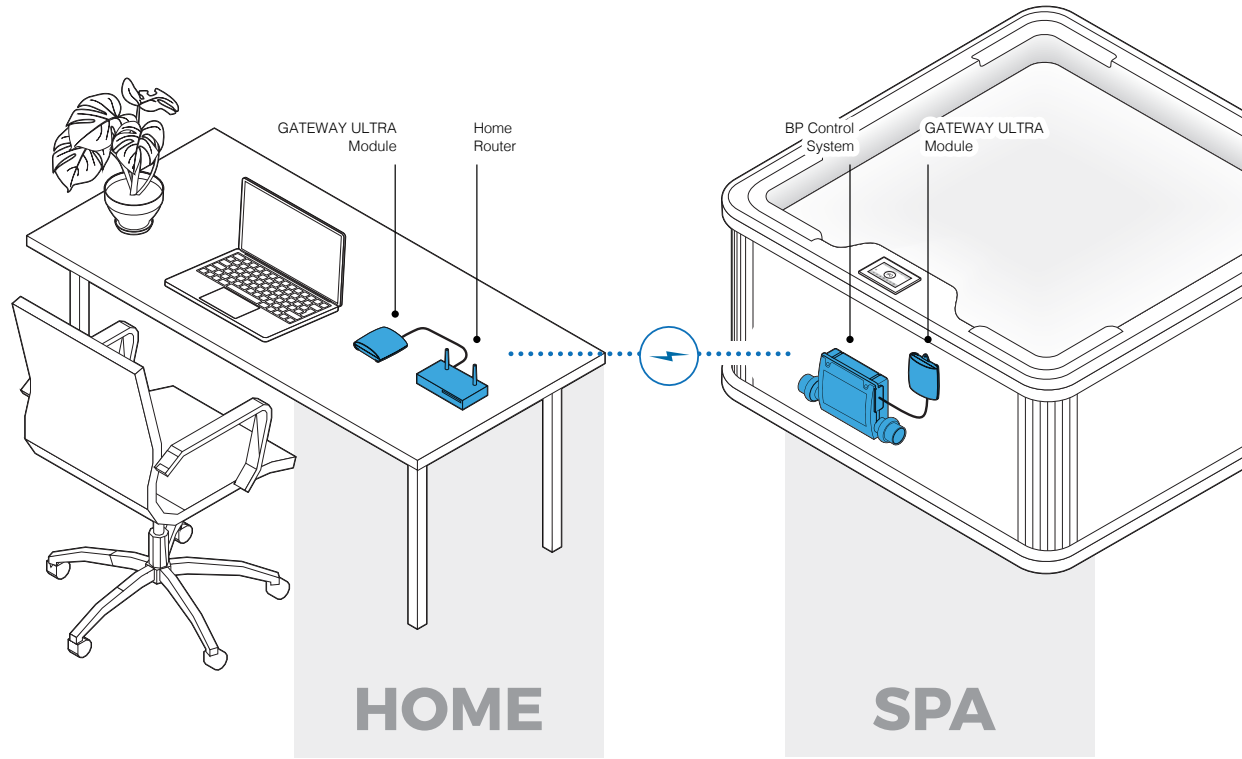

GATEWAY ULTRA Module (side view)

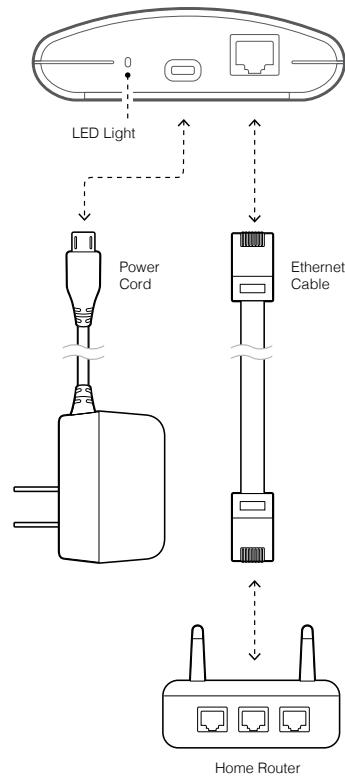

GATEWAY ULTRA Module (side view)

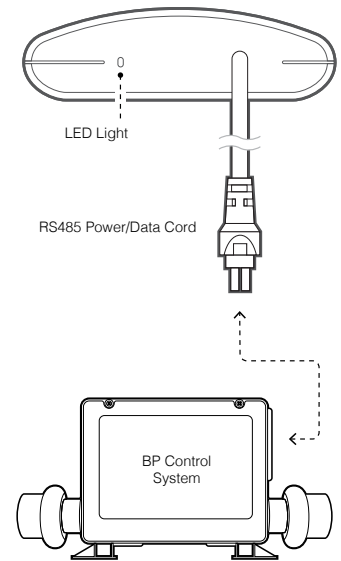

# ControlMySpa™

## Connect GATEWAY ULTRA hardware in your home

### Step 1

Plug the supplied ethernet cable into the home router (A).

### Step 2

Plug the other end of the ethernet cable into the GATEWAY ULTRA module (B).

### Step 3

Plug the supplied power cord into the GATEWAY ULTRA module (C).

### Step 4

Plug the other end of the supplied power cord into wall power (D).





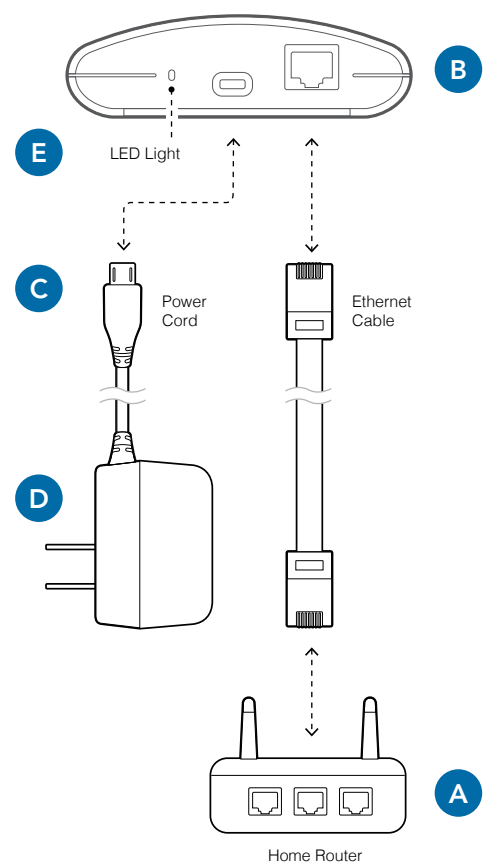

GATEWAY ULTRA Module (side view)



## LED Light Chart (E)

This chart applies to the home and spa GATEWAY ULTRA modules.

-  Red - Solid: The GATEWAY ULTRA and the spa are not connected.
-  Red - Blinking: Home and spa GATEWAY ULTRA modules are connected, but no connection to the spa controller.
-  Blue - Blinking: Remote software update is underway. Do not unplug power.
-  Green - Blinking: CMS™ GATEWAY ULTRA spa and home modules RF is connected, but no connection to internet.
-  Green - Solid: Spa successfully connected to internet. No errors.



# ControlMySpa™ App for the smart device

---

## FOR IPHONE® OR IPAD® (IOS/APPLE)

Search the Apple iOS App Store for  
“controlmyspa”

Or Use this link: <https://goo.gl/j31t1V>



---

## FOR ANDROID® PHONES/TABLETS

Search Google Play App Store for  
“controlmyspa”

Or Use this link: <https://goo.gl/CG4Yci>



**Control your tub  
from your smart device.**

# ControlMySpa™

---

## CMS™ Code Overview

### WHAT IS A CMS™ CODE?

- CMS™ Code is an 8 digit letter/number combination that all Spa owners must have to use spas equipped with the ControlMySpa™ system
  - A. The CMS™ code is obtained from your Dealer.
- Spa owners will need this CMS™ code to setup and connect their spas in the ControlMySpa™ database.
- The CMS™ code connects your spa to your OEM and Dealer for service and support

### EXAMPLE CMS™ Code: ABC-12345

**ABC** = 3 letter code unique to each spa Manufacturer or OEM

**12345** = 5 number code unique to each spa Dealer or Distributor



# ControlMySpa™

## Setup Spa Owner User Account

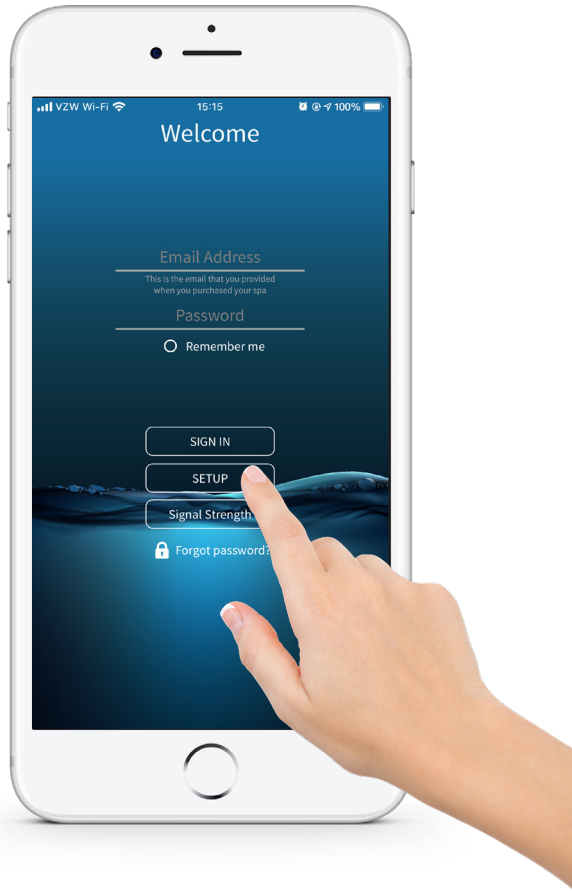

---

**1.**  
**Open the app on  
your smart device**

Press "SETUP" on the app.



---

**2.**  
**Press "Next"**

Confirm Bluetooth is ON in the iOS Settings.

# ControlMySpa™

## Setup Spa Owner User Account

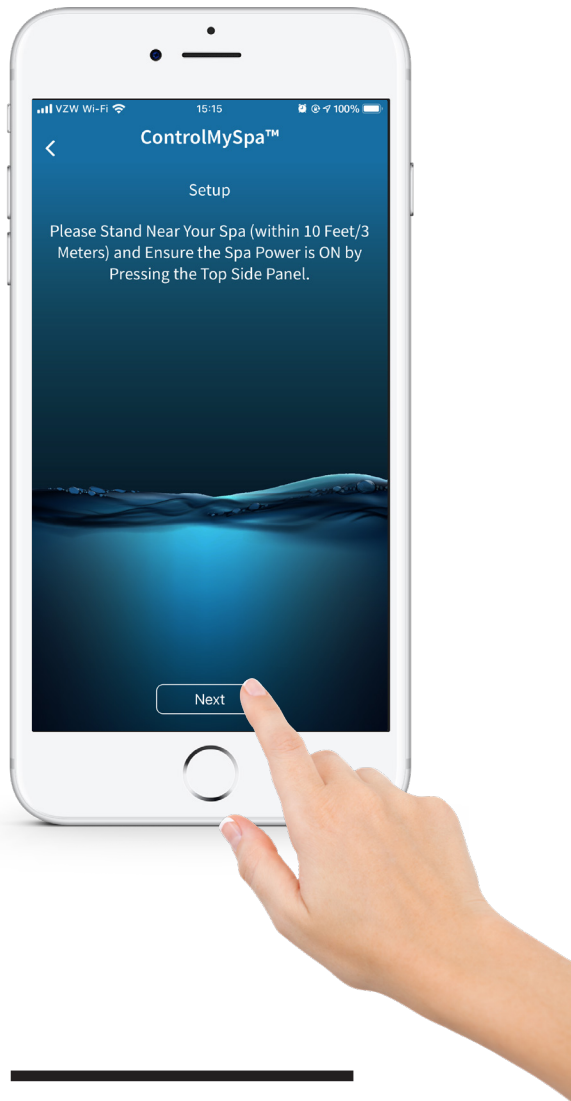

---

### 3. Press “Next”

Stand near your spa (within 10 feet/3 meters) and ensure the spa power is ON by pressing the topside panel. If the spa is powered ON, press “Next”.

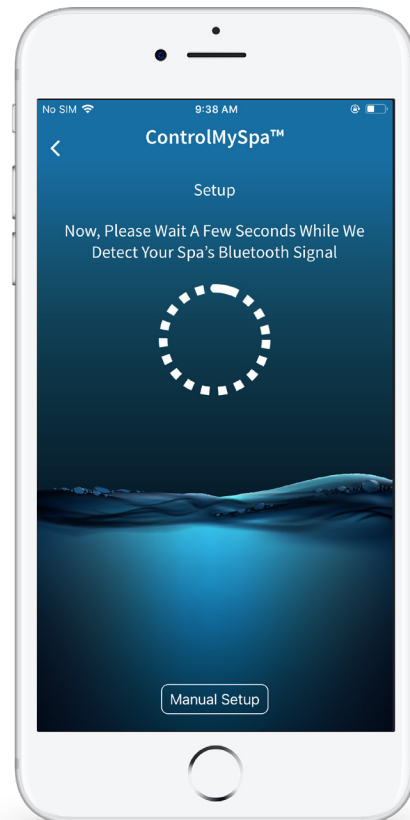

---

### 4. Detect Bluetooth

# ControlMySpa™

## Setup Spa Owner User Account



---

### 5. Press “Yes”

The serial number in the app should match the serial number on the back of the spa module.

---

### 6. Press “Next”

The CMS code is provided by your Dealer. Press “Next”.

# ControlMySpa™

## Setup Spa Owner User Account

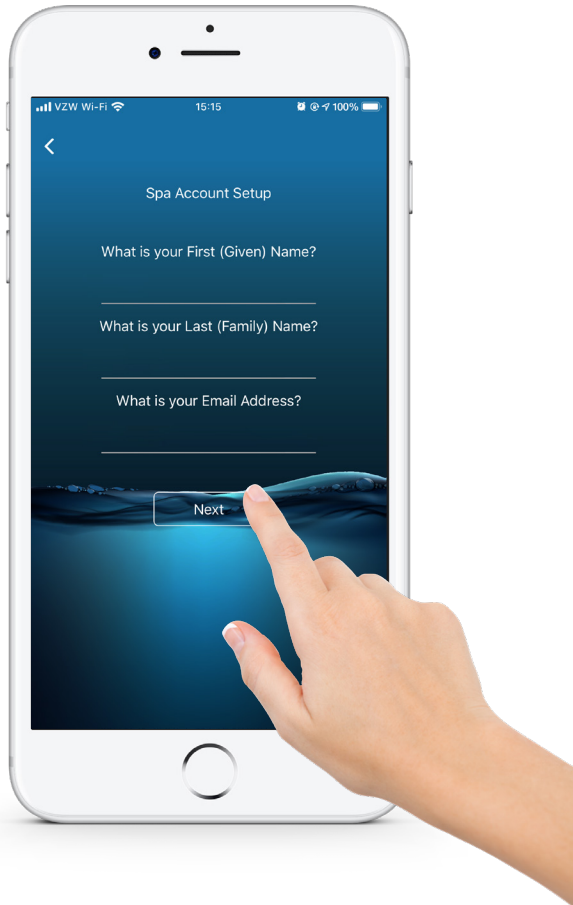

---

### 7. Press "Next"

Input information and press "Next".

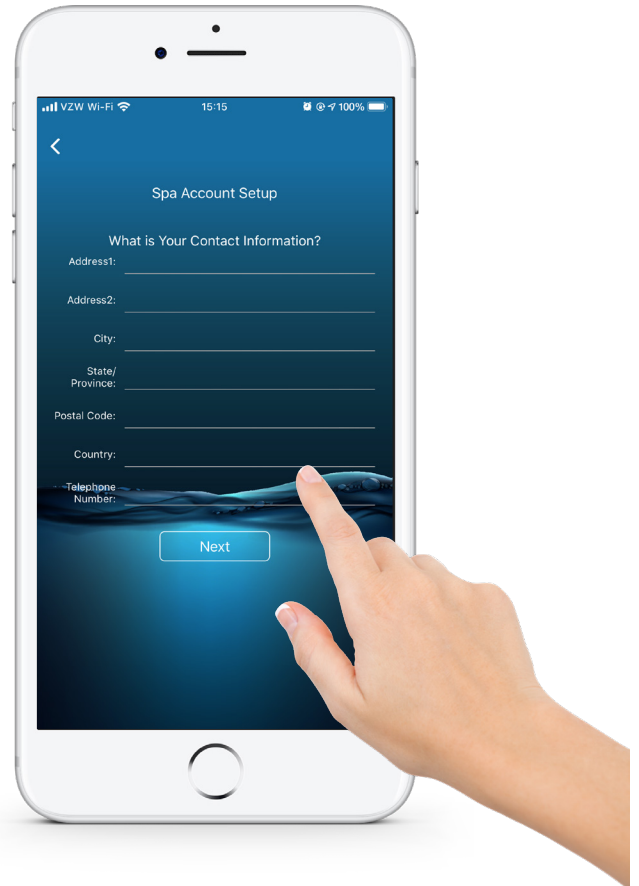

---

### 8. Press "Next"

Input information and press "Next".

# ControlMySpa™

## Setup Spa Owner User Account

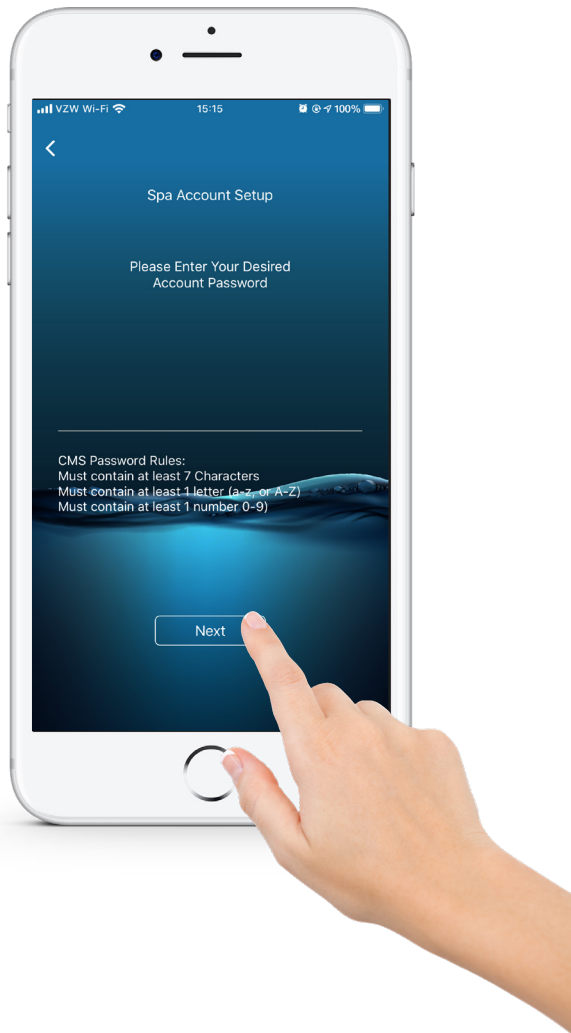

---

### 9. Press "Next"

Input information and press "Next".

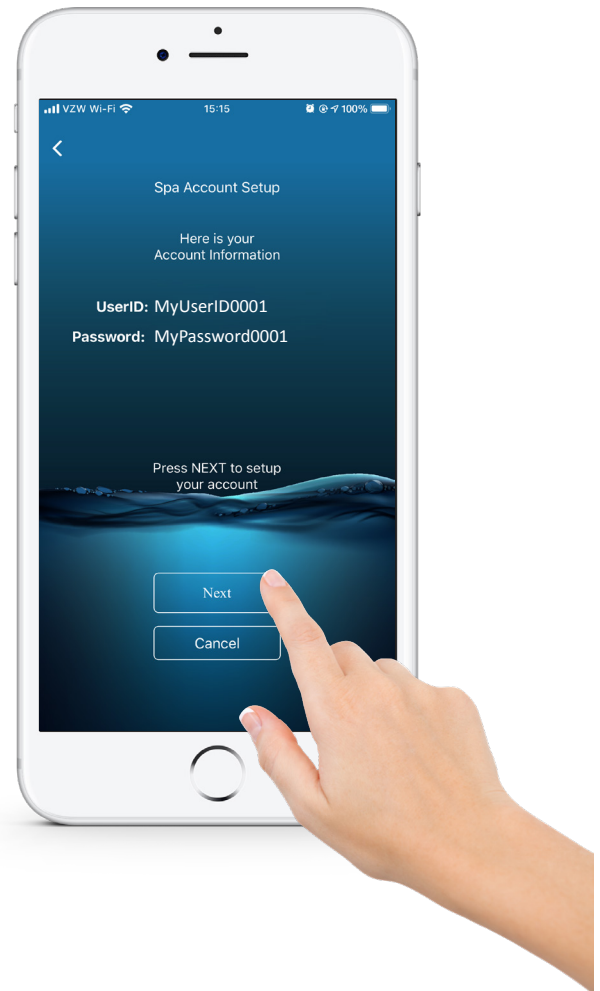

---

### 10. Press "Next"

Your UserID and password will appear. Press "Next".

# ControlMySpa™

## Setup Spa Owner User Account



- 
- 11.**  
Press "Close"



- 
- 12.**  
Press "SIGN IN"

Input your email address, password and press "SIGN IN".

# ControlMySpa™

## Setup Spa Owner User Account

**SUCCESS! YOUR ACCOUNT IS SETUP, AND YOU CAN CONTROL YOUR SPA WITH THE CMS APP.**

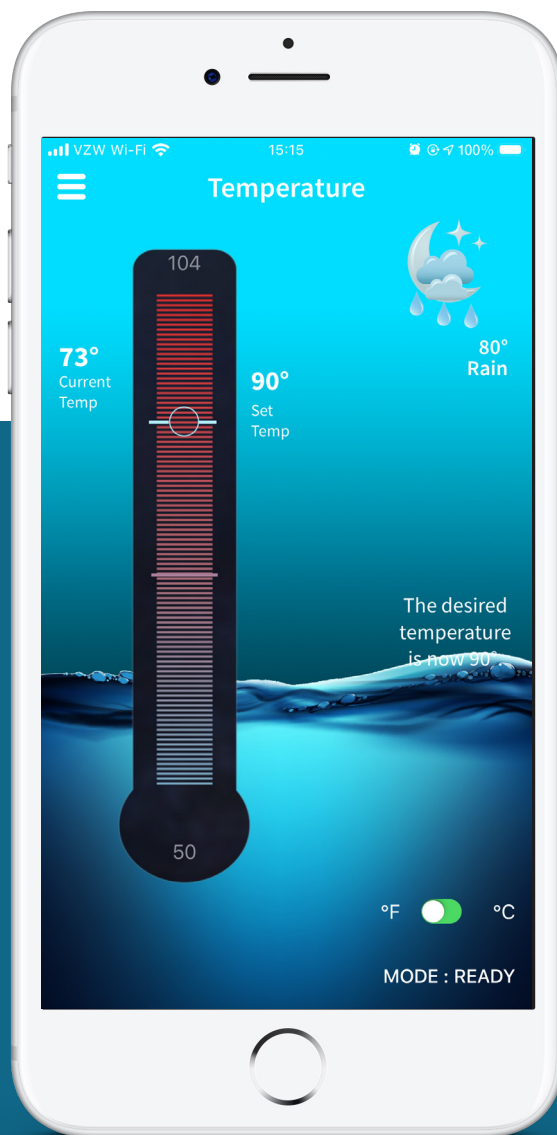



# ControlMySpa™ Spa Owner Account Password

## THE USER ACCOUNT EMAIL WILL RECEIVE AN AUTOMATED EMAIL:

At the e-mail address provided in the set-up, this email provides the new user their **LOG-IN** and **PASSWORD**.

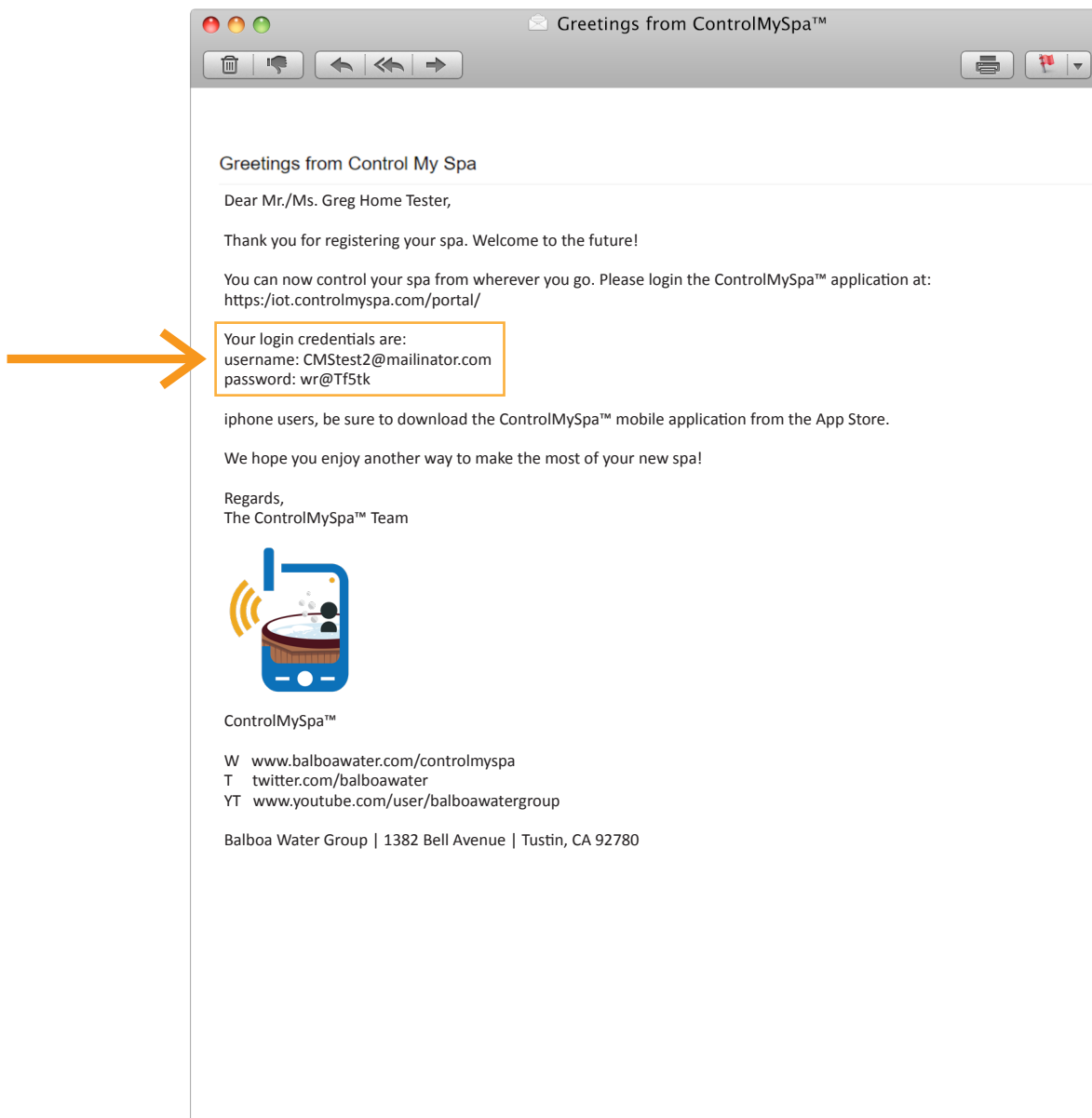

# ControlMySpa™ Website Overview

**SPA OWNER**

# ControlMySpa™

---

## Spa Owner Overview

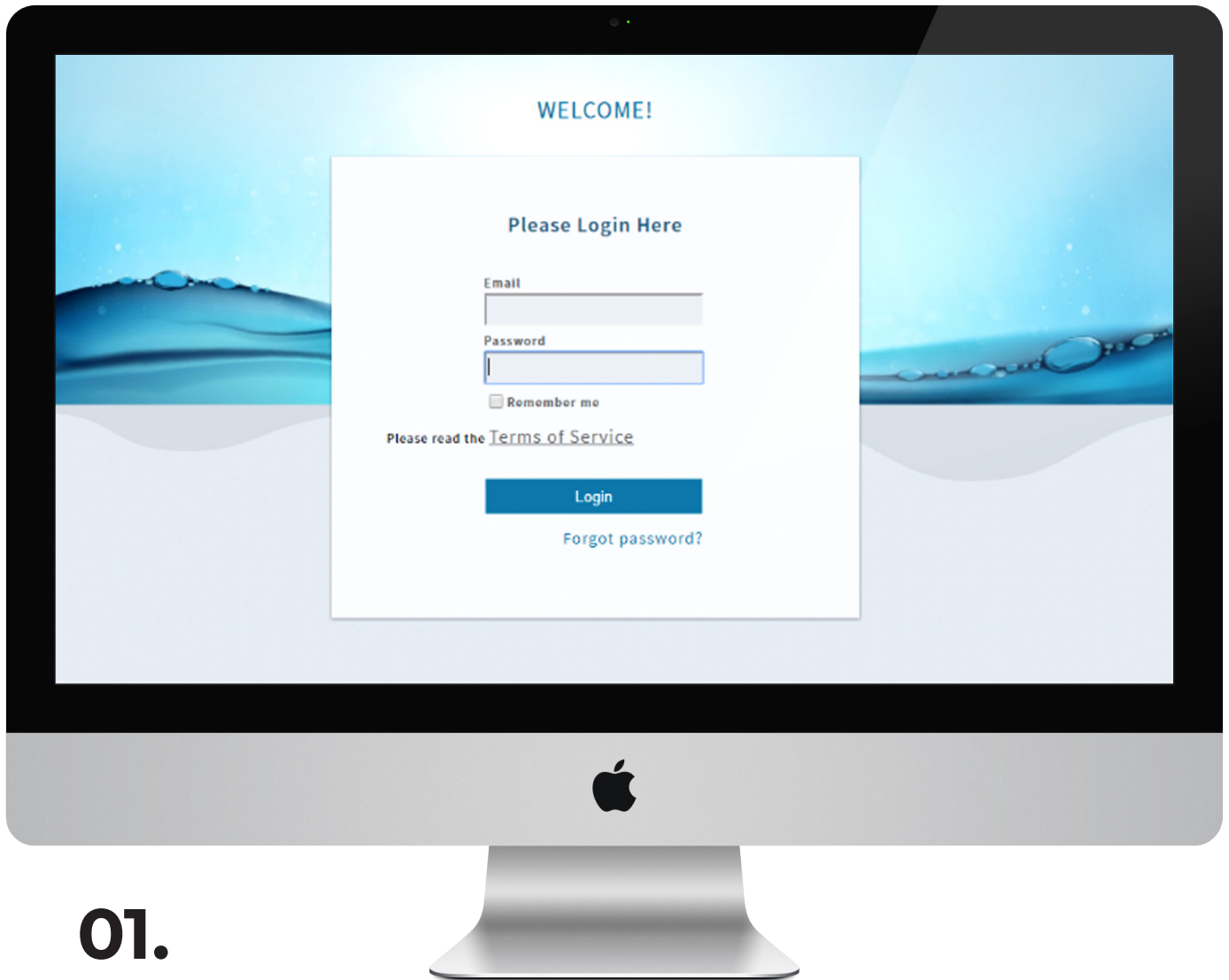

## 01. Web Portal Login

<https://controlmyspa.com>

### Login & Password

- Go to <https://controlmyspa.com> on a computer or tablet web browser. You can also use a phone web browser, but works best on a computer or tablet
- Google Chrome browser is recommended, but works with most other browser

# ControlMySpa™

## Spa Owner Overview

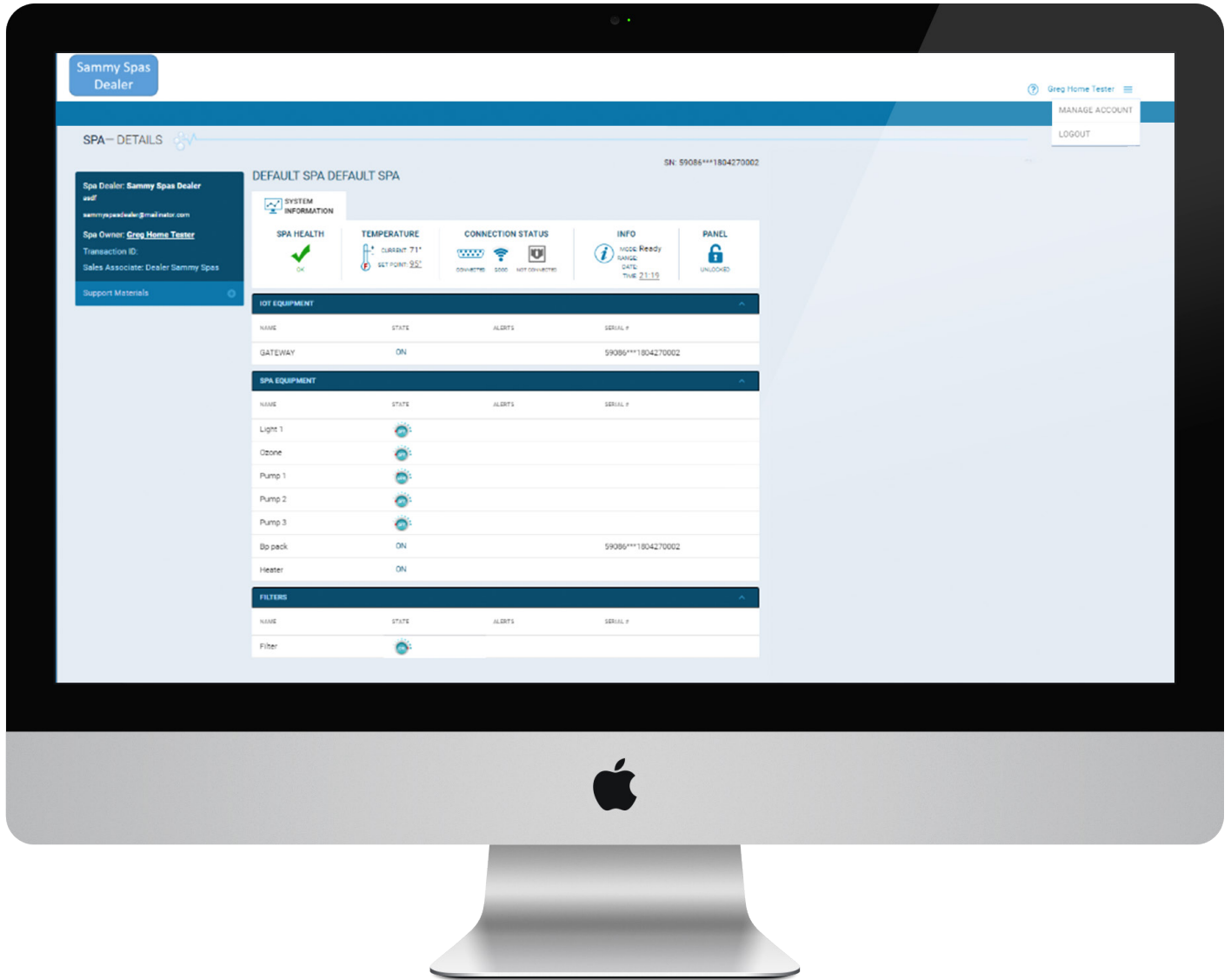

SPA VIEW PAGE

# The Information Menu

## CONTROLMYSPA™ SUPPORT

### Trademark | Patent Notices

The iPhone®, iOS®, iPod® and iPad® are a registered trademark of Apple Inc. The iPhone®, iOS®, iPod® touch and iPad® are a trademark of Apple Inc., registered in the U.S. and other countries.

©Samsung Telecommunications America, LLC (“Samsung”). Samsung, Galaxy S, Super AMOLED, and AllShare are all trademarks of Samsung Electronics Co., Ltd. and/or its related entities. Other company names, product names and marks mentioned herein are the property of their respective owners and may be trademarks or registered trademarks. Appearance of device may vary.

Wi-Fi®, the Wi-Fi CERTIFIED logo, and the Wi-Fi logo are registered trademarks of the Wi-Fi Alliance.

Google, Google Play and other marks are trademarks of Google, Inc.

CMS, ControlMySpa™, BALBOA WATER GROUP and the stylized logo are registered trademarks or applications applied for in the US Patent & Trademark Office. All rights reserved. All other product or service names are the property of their respective owners.

Products are covered under one of more

of the following US Patents: 5332944, 5361215, 5550753, 5559720, 5,883,459, 6282370, 6590188, 7030343, 7, 417, 834 B2 & Canadian Pt 2342614 plus others. Other patents both foreign and domestic applied for and pending.

### Compatibility

#### Apple iOS

The iOS® app version requires iOS 9.0 or later. Compatible with iPhone, iPad, and iPod touch.

#### Android

Requires Android 4.0 and up

## INTELLECTUAL PROPERTY ADVISEMENT

All Intellectual property, as defined below, owned by or which is otherwise the property of Balboa Water Group or its respective suppliers relating to the Balboa Water Group BP Spa Control Systems, including but not limited to, accessories, parts, or software relating to the “System”, is proprietary to Balboa Water Group and protected under federal laws, state laws, and international treaty provisions. Intellectual Property includes, but is not limited to, inventions (patentable or unpatentable), patents, trade secrets, copyrights, software, computer programs, and related documen-

tation, and other works of authorship. You may not infringe or otherwise violate the rights secured by the Intellectual Property. Moreover, you agree that you will not (and will not attempt to) modify, prepare derivative works of, reverse engineer, decompile, disassemble, or otherwise attempt to create source code from the software. No title to or ownership in the Intellectual Property is transferred to you. All applicable rights of the Intellectual Property shall remain with Balboa Water Group and its suppliers.



## ControlMySpa™

✉ Email

[info@balboawater.com](mailto:info@balboawater.com)

☎ Phone

P : + 714.384.0384  
Customer Service is available:  
M — T 7:30AM to 7:00PM  
F — 7:30AM to 5:00PM PT

📍 Corporate Office

Balboa Water Group  
3030 Airway Avenue  
Costa Mesa, CA 92626

**MEXICO OPERATIONS**  
Balboa Water Group  
Aguila Azteca 6011  
Baja Maq. El Aquila  
Mexico 22221

**EUROPEAN OPERATIONS**  
Balboa Water Group  
Hydroair International  
ApS Roustvej 50 DK-6800  
Varde